

# CHAPTER 11

## BENT GLASS CORNER WINDOW AND CURVED GLASS INDEX

	<b>PAGE</b>
History .....	11.2
Part Identification – Bent Glass Wood Corner Unit .....	11.3
Part Identification – Wood Curved Glass Single Hung .....	11.4
Part Identification – Wood Curved Glass 1" Picture Unit .....	11.5
Parts – Curved Glass Single Hung .....	11.6
Balances .....	11.8
Jamb Liners .....	11.9
Replacement Wood Parts – Curved Glass Single Hung .....	11.10
Replacement Wood Parts – Bent Glass Corner Unit .....	11.11
Sash Replacement – Curved Glass Single Hung .....	11.12
Weatherstrip – Curved Glass Single Hung .....	11.13
Half Screens and Screen Parts – Curved Glass Single Hung .....	11.14
Obsolete Parts – Curved Glass Single Hung .....	11.15

**HISTORY**

PRODUCED	UNIT TYPE	FEATURES OR CHANGES	DISCONTINUED
1989	Curved Glass Single Hung Windows	Unit features 3/4" insulating glass, 4 9/16" jambs, exterior half screen, single hung operating sash, beige vinyl single track jamb hardware system with balance tubes and cam style sash lock.	1999
	Curved Glass Picture Window	Unit features 1" insulating glass with 4 9/16" jambs. Curved glass single hung and curved glass picture window units feature standard 72" radius for curved or flat wall application. Interior trim included.	
1990	Bent Glass Corner Window	Unit features 1" insulating glass bent at 90 degrees, 4 9/16" jambs, mitered dowel reinforced corners, clear brick mould casing and subsill.	1999
1991	Bent Glass Corner Window	Single glazed option introduced.	Present
1999	Curved and Bent Glass Windows	IG option no longer available. SG option available on a special order basis	Present

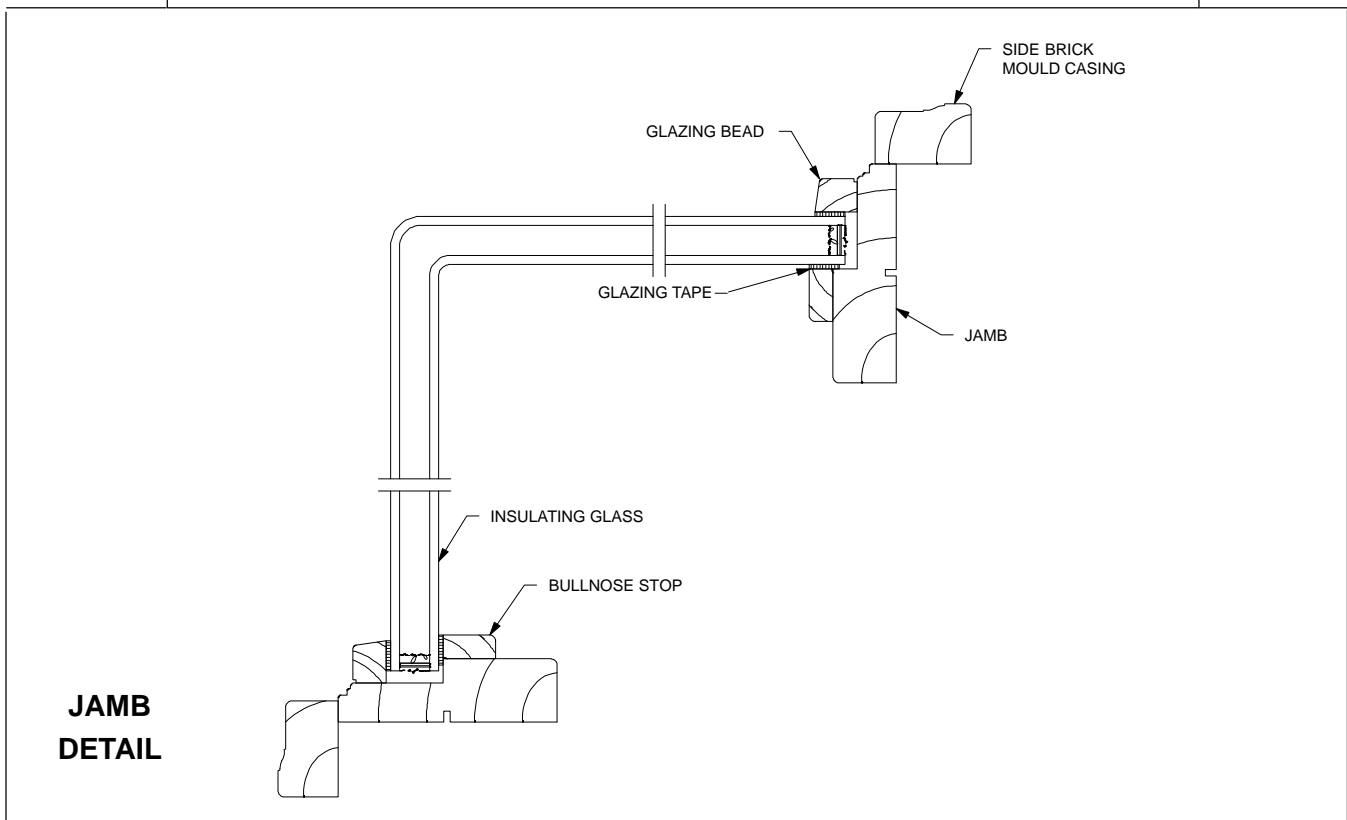
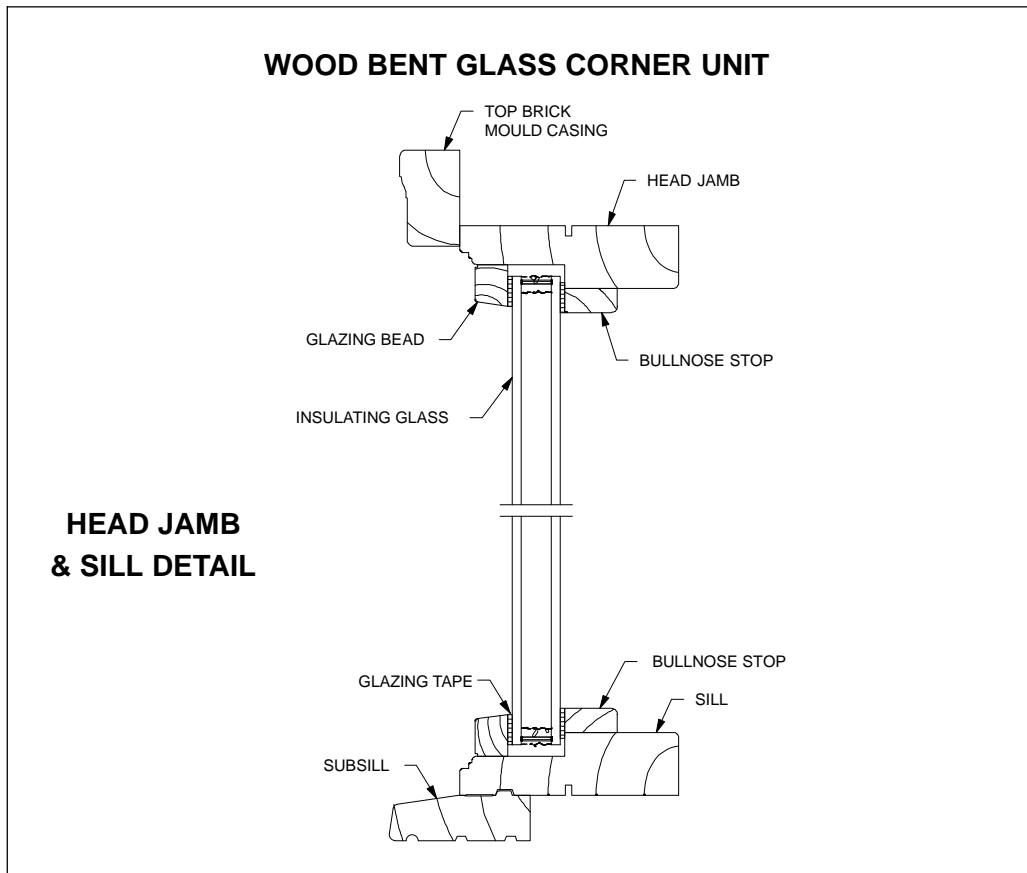

NOTE: Not to scale; specifications subject to change without notice.

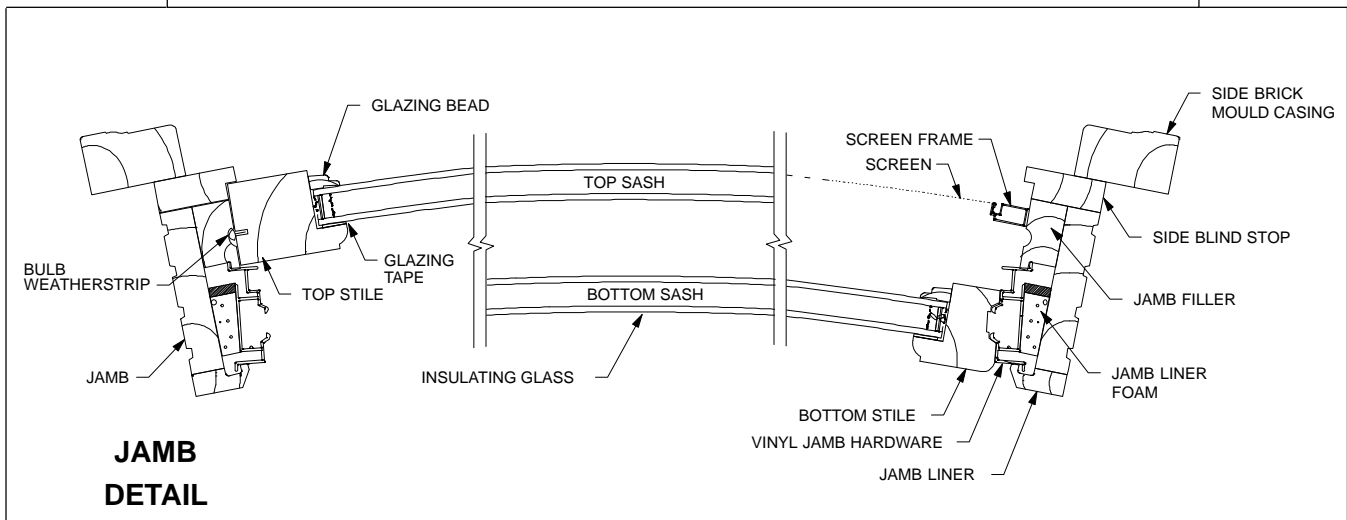
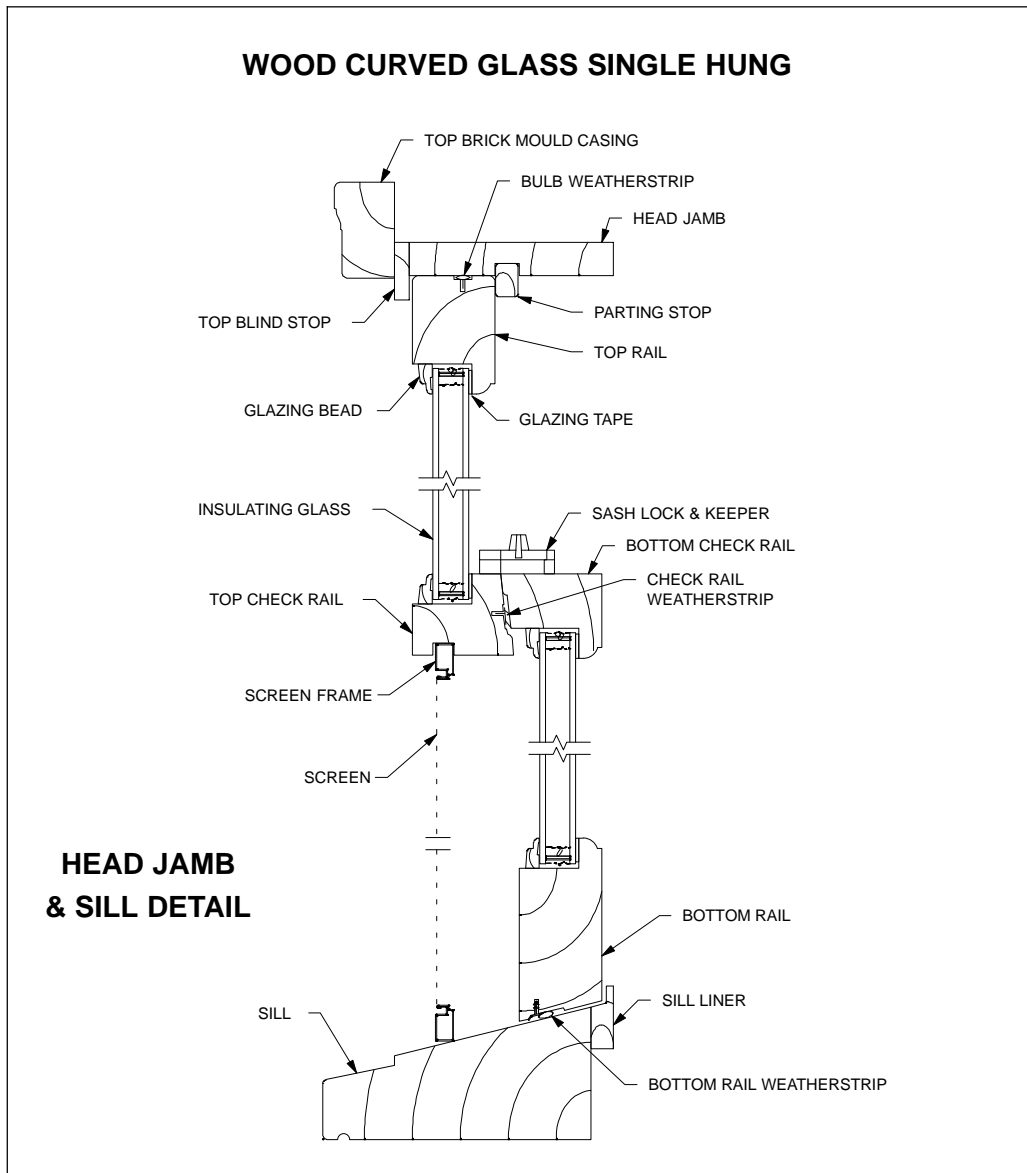

NOTE: Not to scale; specifications subject to change without notice.

**WOOD CURVED GLASS 1" PICTURE UNIT**

**HEAD JAMB  
 & SILL DETAIL**

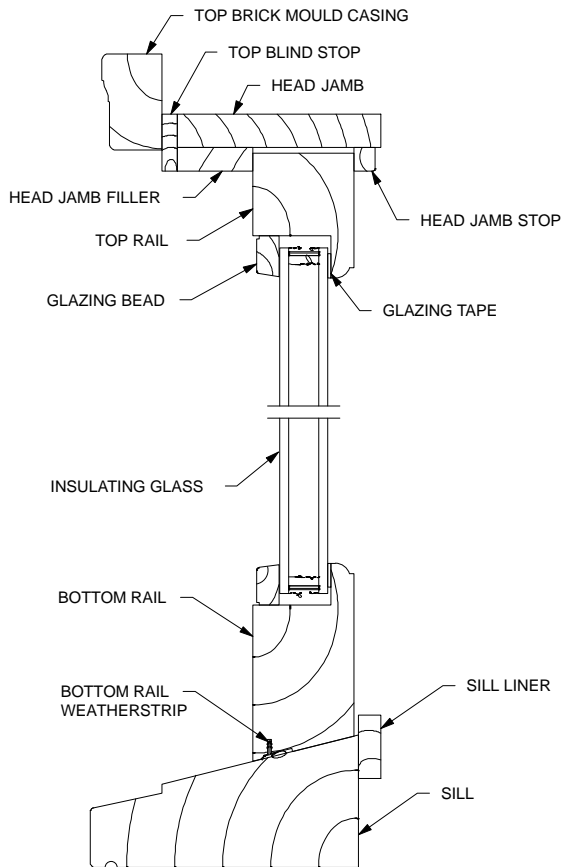

**JAMB  
 DETAIL**

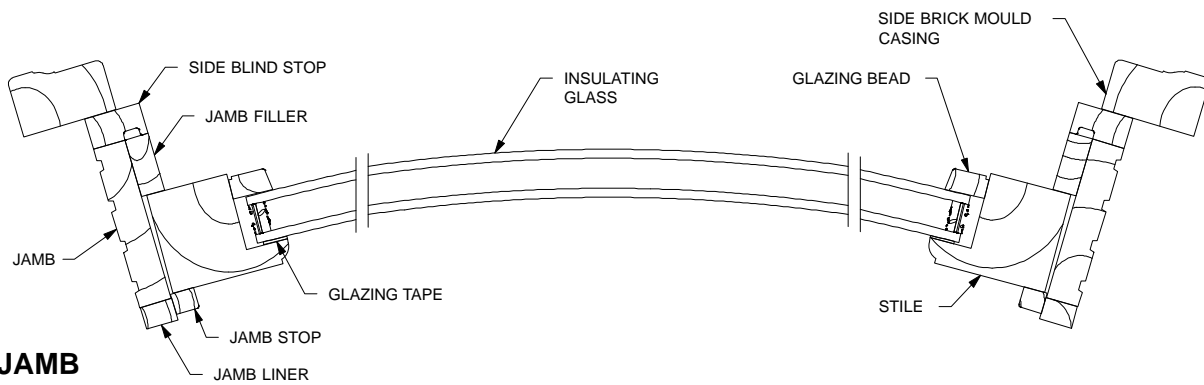

NOTE: Not to scale; specifications subject to change without notice.

When ordering replacement Curved Glass Single Hung parts specify:

1. type of unit;
2. part number;
3. description.

ILLUSTRATION NOT TO SCALE	DESCRIPTION	OPER./ COLOR	PART NO.
 <p>Left Hand      Right Hand</p>	<p><b>Sash Pivot, Winged</b></p> <p><i>Includes:</i>                      1 – Sash pivot                      1 – 1 5/8" Phillips trimhead self tapping screw</p> <p>NOTE: Pivot handing is viewed from the interior.</p>	<p>LH RH</p>	<p>11869348 11869347</p>
	<p><b>Sash Lock and Keeper, Complete</b></p> <p><i>Includes:</i>                      1 – Sash lock                      BZ – 10818033                      WH – 10840026                      BS – 05600082                      1 – Keeper                      BZ – 10818032                      WH – 10840012                      BS – 05600083                      4 – #7x7/8" Phillips flathead wood screws</p> <p style="text-align: right;">Package of 200</p>	<p>BZ WH</p> <p>BZ WH</p>	<p>11869395 11869396</p> <p>11900920 11900910</p>
	<p><b>Sash Lock, Keyed</b></p> <p><i>Includes:</i>                      1 – Keyed lock                      2 – Keys                      2 – #6x1" Phillips flathead wood screws</p>	<p>BZ WH</p>	<p>05590632 05590633</p>
	<p><b>Keeper</b>                      For keyed sash lock</p> <p><i>Includes:</i>                      1 – Keeper                      2 – #6x1" Phillips flathead wood screws</p>	<p>BZ WH</p>	<p>10817043 10840014</p>
	<p><b>Sash Lift</b></p> <p><i>Includes:</i>                      1 – Sash lift                      2 – #8x1" Slotted ovalhead screws</p>	<p>BZ WH BS</p>	<p>10500557 10500556 10500558</p>

ILLUSTRATION NOT TO SCALE	DESCRIPTION	OPER./ COLOR	PART NO.
	<p><b>Sash Stop, Vinyl</b>                      V177                      1 3/4" (44) length</p>	WH BG	11860114 11860116
	<p><b>S-Hook Heavy Duty, Long, 3/8" (10) Wide</b>                      Bottom sash balance                      Used for Extra Heavy Duty 2 balance</p>		11870741
	<p><b>Foam Plug (Chimney Block)</b>                      Located at the bottom of the vinyl jamb liner                      1"x9/16"x3/4"</p>	WH	10502001
	<p><b>Foam, Adhesive Backed</b>                      Foam block on the back of the jamb liner                      1/2"x1 1/2"x3/8"</p>	BK	10500200
	<p><b>Foam Jamb Liner, Curved Glass Single Hung</b>                      MISC 004                      With PVC edge                      9/16"x1 7/16"</p>	Specify Length	10500014

**SINGLE HUNG BALANCES 1989 TO PRESENT**

To order single hung balances specify:

1. part number;
2. size.

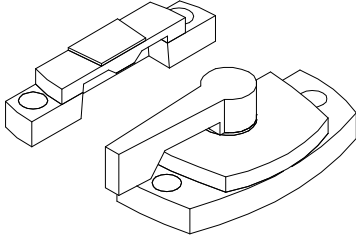
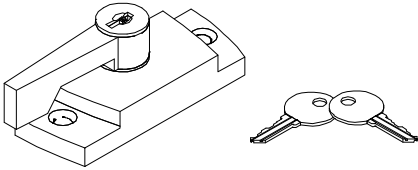
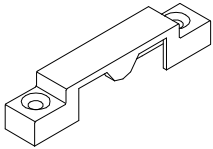
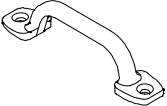
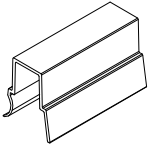
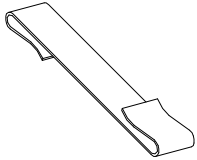
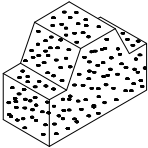
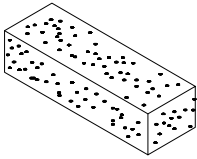
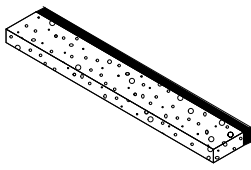
NOTE: Size of balance is imprinted on tube.

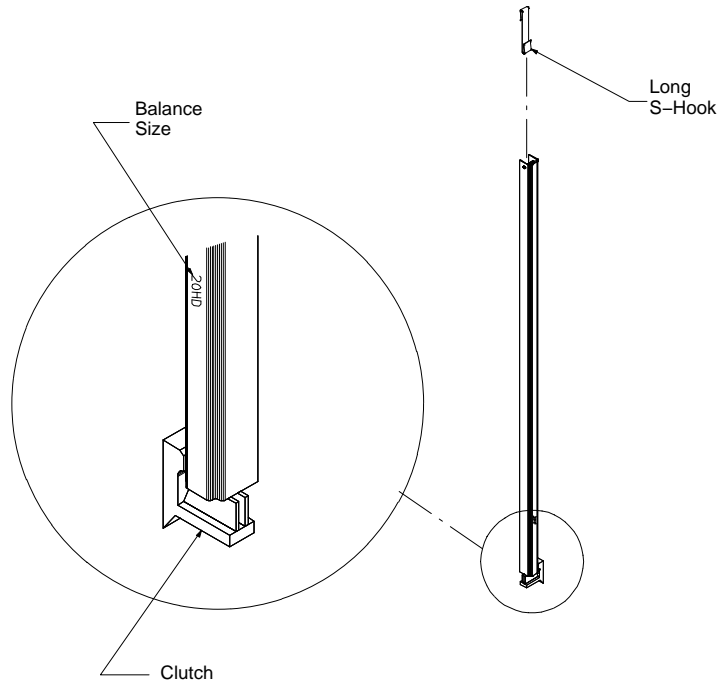

NOTE: All curved glass single hung units utilize a heavy duty balance with a black clutch.

Size	Marvin Part Number
20 HD	10672000
24 HD	10672400
28 HD	10672800



**ORDERING REPLACEMENT JAMB LINERS  
 FOR CURVED GLASS SINGLE HUNG UNITS**

Replacement flange mounted foam backed jamb liners include pile weatherstrip (dust fuzzy), foam plug (chimney block), foam gaskets and sash stops.

To order specify:

1. part number (if standard) or length (dimension A in illustration) if special;
2. flange mount;
3. color;

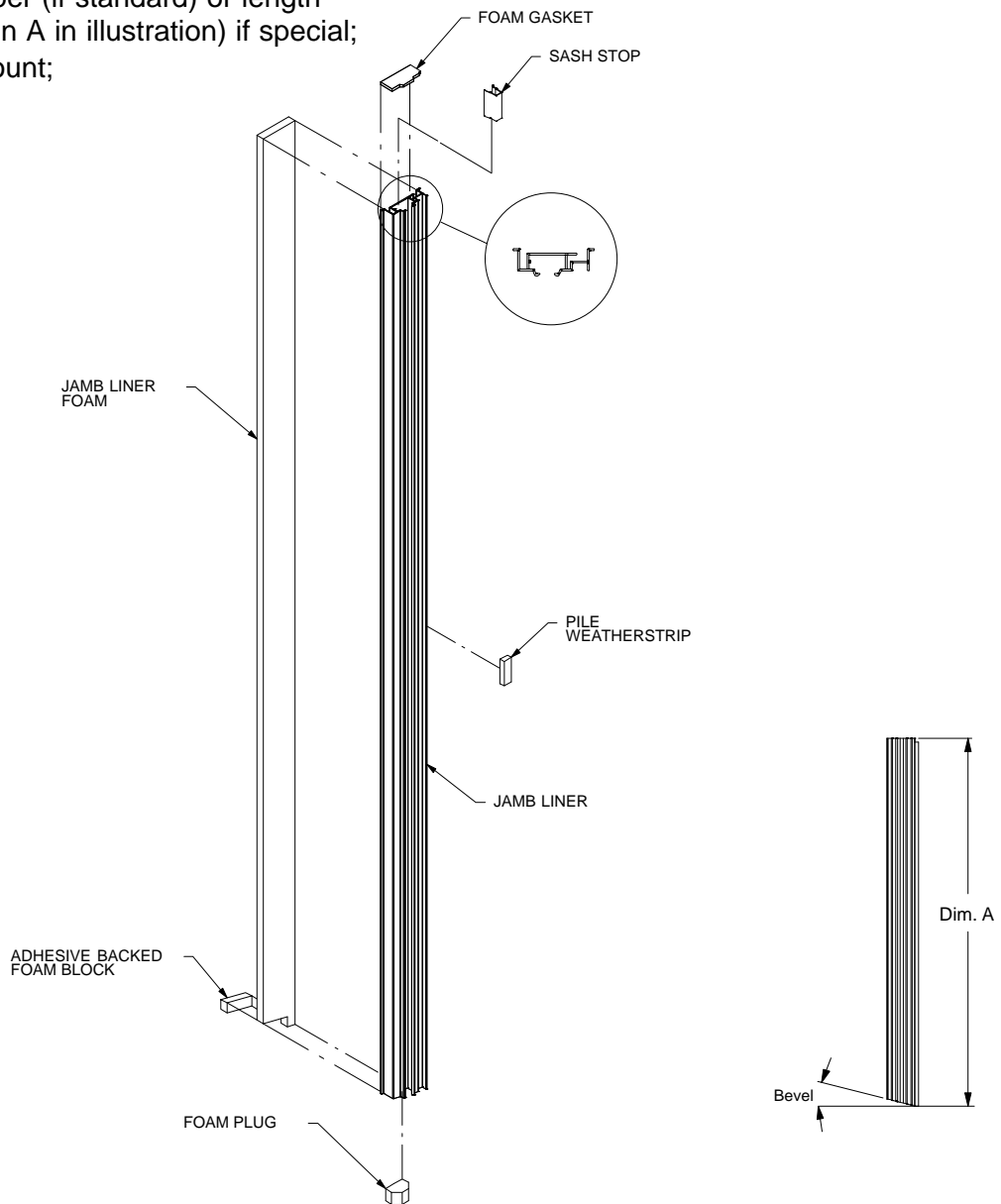

Glass Height (one sash)	Part Number (White)	Part Number (Beige)
20" pair	10502000	10502010
24" pair	10502400	10502410
28" pair	10502800	10502810

**REPLACEMENT WOOD PARTS**

Top Blind Stop	W6161
Side Blind Stop	W7107
Parting Stop	W7109
Jamb Filler	W7106
Sash Opening Filler	W7108
Sill Liner (with foam)	W7124
Jamb Liner	W7105
Bullnose Stop Wood Bent Glass Corner Unit	W7013

<b>Picture Units</b>	
Sill Liner, Picture	W6200
Jamb Liner, Picture	W6082
Side Blind Stop, Picture	W7084
Head Jamb and Jamb Stop, Picture	W7010
Head Jamb Filler, Picture	W6045
Jamb Filler, Picture	W6043

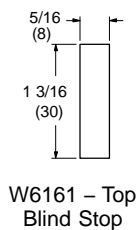

W6161 – Top Blind Stop

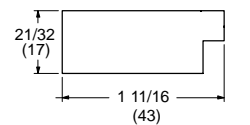

W7107 – Side Blind Stop

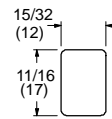

W7109 – Parting Stop

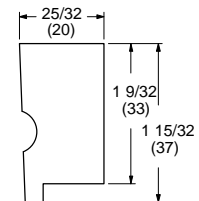

W7106 – Jamb Filler

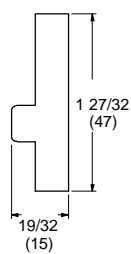

W7108 – Sash Opening Filler

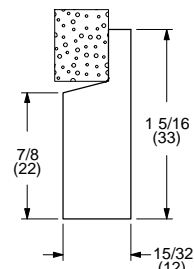

W7124 – Sill Liner w/ Adhesive Foam

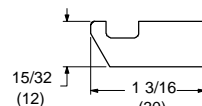

W7105 – Jamb Liner

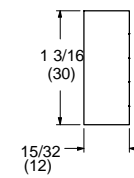

W6200 – Sill Liner, Picture

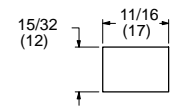

W6082 – Jamb Liner, Picture

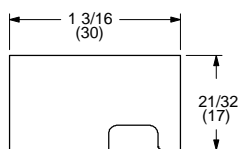

W7084 – Side Blind Stop, Picture

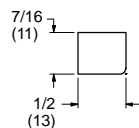

W7010 – Head Jamb and Jamb Stop, Picture

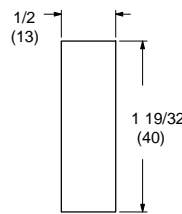

W6045 – Head Jamb Filler, Picture

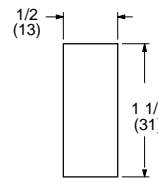

W6043 – Jamb Filler, Picture

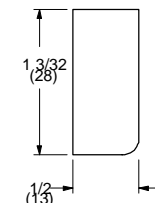

W7013 – Bullnose Stop

**TO ORDER REPLACEMENT WOOD PARTS**

When ordering replacement wood parts specify:

1. profile number;
2. call number or rough opening;
3. length;
4. finish;
5. radius (if applicable).

## ORDERING REPLACEMENT SASH FOR CURVED GLASS SINGLE HUNG

When ordering replacement sash specify:

1. which sash is being replaced – top, bottom or pair;
2. size;
  - a. top or bottom (call number or OM height, exterior arc and chord length of sash)
  - b. pair (call number or sash opening – indicate if unequal sash)
3. glazing;
4. finish.

## ORDERING REPLACEMENT SASH FOR CURVED GLASS PICTURE UNITS

To order replacement picture sash specify:

1. size;
  - a. (call number or OM height, exterior arc and chord length of sash)
2. glazing;
3. finish.

## ORDERING REPLACEMENT GLASS FOR CURVED GLASS SINGLE HUNG OR PICTURE UNITS

NOTE: Replacement glass is stocked for all standard Curved Glass Single Hung and/or Picture Units by part number. Part numbers are etched in the lower right hand corner of each Curved Glass IG unit, as viewed from the interior. If replacement glass is required, reference this part number when ordering.

To order replacement glass specify:

1. part number.

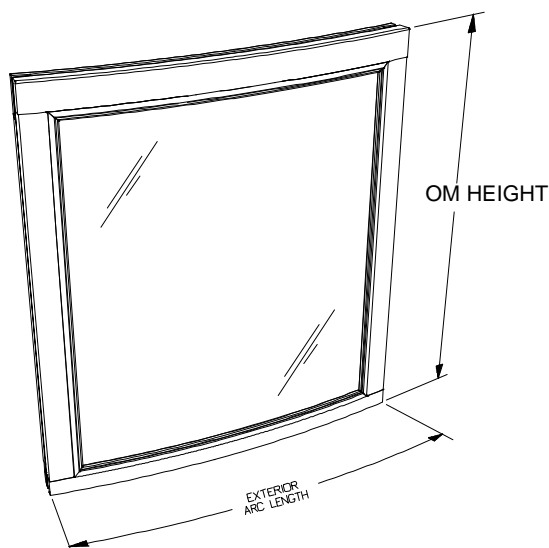

**Exterior View**

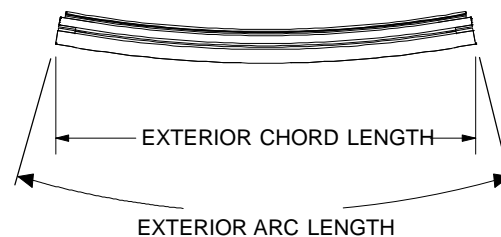



**Top View**

**ORDERING REPLACEMENT WEATHER STRIP FOR CURVED GLASS**

When ordering replacement weather strip specify:

1. quantity;
2. color;
3. part number;
4. description.

<b>ILLUSTRATION</b> <i>NOT TO SCALE</i>	<b>DESCRIPTION</b>	<b>LENGTH</b>	<b>PART NUMBER</b>
	<b>Bulb Weather Strip, Bottom Rail</b> V192 Color: Beige	84" (2134)	15900058
	<b>Dual Seal Weather Strip, Check Rail</b> V116 Color: White	84" (2134)	15828400
	<b>Bulb Weather Strip, Top Rail and Top Stile</b> V113 Color: Beige	150" (3810)	15619698

**ORDERING REPLACEMENT HALF SCREENS FOR CURVED GLASS SINGLE HUNG**

Half screens are available with aluminum surround and charcoal colored fiberglass 18 x 16 screen mesh. Aluminum mesh is available as an option in black, charcoal, bright aluminum, or bright bronze. Determine the outside measurement of the existing screen. Find the sizes that correspond to the exterior arc length and OM height indicated on the following chart. Surrounds are available in bronze, white, brown and pebble gray.

When ordering replacement screen specify:

1. size;
2. color;
3. mesh type (if other than standard).

Half Screen For Curved Glass Single Hung Units			
WIDTH		HEIGHT	
SIZE	EXTERIOR ARC LENGTH	SIZE	OM HEIGHT
CN 24	25 3/4"	CN 20	23 13/32"
CN 28	29 25/32"	CN 24	27 13/32"
CN 32	33 7/8"	CN 28	31 13/32"

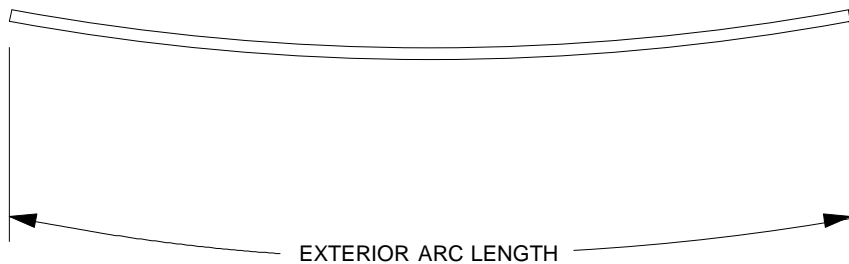

NOTE: Horizontal screen size is taken from the exterior arc length of screen and includes screen corners.



**CURVED GLASS SINGLE HUNG SCREEN PARTS**

When ordering replacement parts specify:

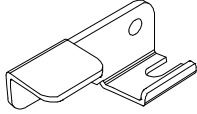
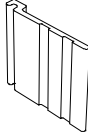
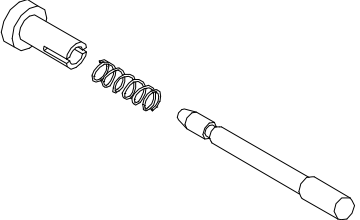
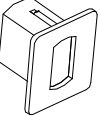
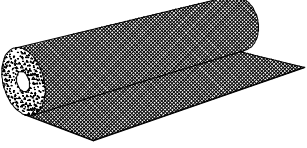
1. part number;
2. quantity.

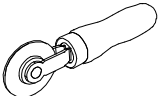
ILLUSTRATION NOT TO SCALE	DESCRIPTION	COLOR	PART NO.
	<p><b>Screen Latch</b>  <i>Includes:</i>                      1 – Screen latch                      1 – Rivet with plastic washer                      1 – SS #8x1 1/4" Phillips ovalhead wood screw</p>	Mill Finish	11040361
	<p><b>Finger Pull</b>                      V254</p>	Clear	11860350
	<p><b>Plunger and Spring Assembly</b>                      M060  <i>Includes:</i>                      1 – Plunger bolt                      1 – Plunger bolt cap                      1 – Plunger bolt spring</p>	Clear	11900890
	<p><b>Screen Mounting Receptacle</b>                      M110</p>	Clear	11867851
	<p><b>Screen Cloth, 18x16 Fiberglass Mesh</b></p> <p style="text-align: right;">36" x 600'                      48" x 300'                      72" x 300'</p>	Charcoal	11253600 11254800 11257200
	<p><b>Spline, Screen</b>                      V126</p>	Black	NA
	<p><b>Spline Roller</b>                      Tool for re-screening</p>		02590541

When ordering replacement parts specify:

1. quantity;
2. part number;
3. description.

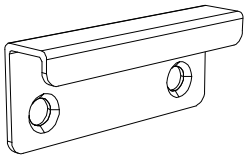
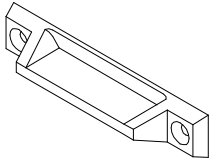
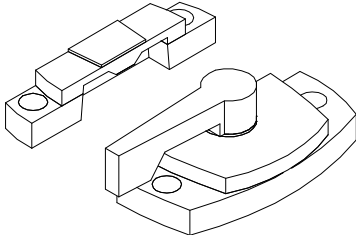
ILLUSTRATION NOT TO SCALE	DESCRIPTION	OPER./ COLOR	PART NO.
	<p><b>Jamb Bracket, Top Sash</b></p> <p>Used between 1989 –1992</p> <p><i>Includes:</i>                      1 – Jamb bracket                      2 – #4X3/4" Phillips flathead wood screws</p>	<p>ZYD</p>	<p>(11040362) NA</p>
	<p><b>Sash Lift</b></p> <p><i>Includes:</i>                      1 – Sash lift                      2 – #10x1" Phillips flathead wood screws</p>	<p>BZ                      WH                      BS</p>	<p>Check                      availability</p>
	<p><b>Sash Lock and Keeper, Complete</b></p> <p><i>Includes:</i>                      1 – Sash lock                      BZ – 10818033                      WH – 10840026                      BS – available in package only                      1 – Keeper                      BZ – 10818032                      WH – 10840012                      BS – available in package only                      4 – #7x7/8" Phillips flathead wood screws</p> <p style="text-align: right;">Package of 200</p>	<p>BS</p>	<p>(05600051)NA</p>